

PEX MULTI LAYER PIPES AND FITTINGS



COMPLY WITH BS EN ISO 21003-1:2008
 BS EN ISO 21003-3:2008
 BS EN ISO 21003-5:2008
 BS EN 12165:2016
 AS/NZS 4020:2005
 SS 375:2015



F6 PUSH-FIT PEX END CAP

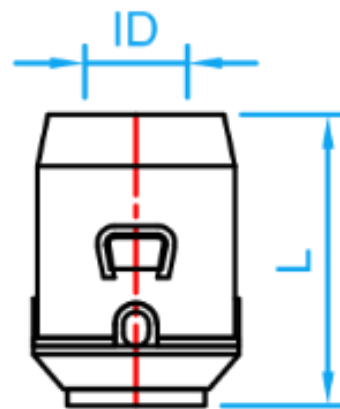

SIDE VIEW

DIMENSIONS

SKU	SIZE (mm)	ID (mm)	L (mm)	WEIGHT (kg)	PCS/CTN
PEXF6EC16	16	11.80	34.0	0.037	288
PEXF6EC20	20	15.80	35.5	0.054	192
PEXF6EC25	25	19.75	40.5	0.086	128
PEXF6EC32	32	25.75	46.0	0.142	108