

PEX MULTI LAYER PIPES AND FITTINGS



COMPLY WITH BS EN ISO 21003-1:2008
 BS EN ISO 21003-3:2008
 BS EN ISO 21003-5:2008
 AS/NZS 4020:2005
 SS 375:2015



F6 PUSH-FIT PEX MI ELBOW

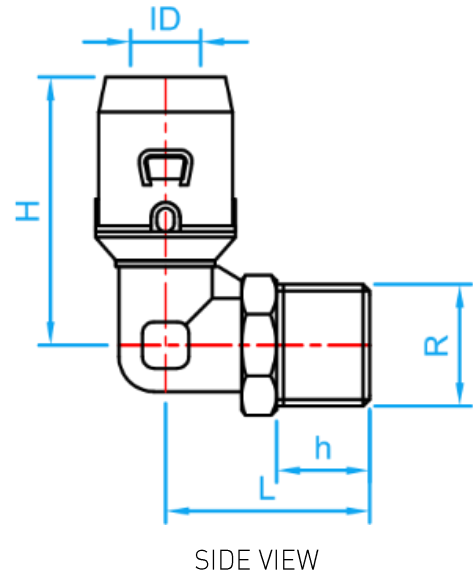

DIMENSIONS

SKU	SIZE (mmxinch)	ID (mm)	R BSPT (inch)	h (mm)	L (mm)	H (mm)	WEIGHT (kg)	PCS/CTN
PEXF6MIE16	16X1/2"	11.80	1/2"	14.0	35	46.0	0.074	144
PEXF6MIE1620	16X3/4"	11.80	3/4"	15.0	36	48.5	0.093	96
PEXF6MIE2016	20X1/2"	15.80	1/2"	14.0	37	47.0	0.093	80
PEXF6MIE20	20X3/4"	15.80	3/4"	15.0	38	50.0	0.112	80
PEXF6MIE2520	25X3/4"	19.75	3/4"	15.0	42	56.0	0.153	96
PEXF6MIE25	25X1"	19.75	1"	16.0	43	60.0	0.196	80
PEXF6MIE3220	32X3/4"	25.75	3/4"	15.0	45	62.0	-	-
PEXF6MIE3225	32X1"	25.75	1"	16.0	46	65.0	0.252	48
PEXF6MIE32	32X1 1/4"	25.75	1 1/4"	19.5	45	68.5	0.290	40